

**GENERAL PARTITIONS**

*Inc. Corp.*  
1702 Peninsula Drive, Erie PA  
P.O. Box 8370, Erie, PA 16505-0370  
Phone (814) 833-1154 FAX (814) 838-3473

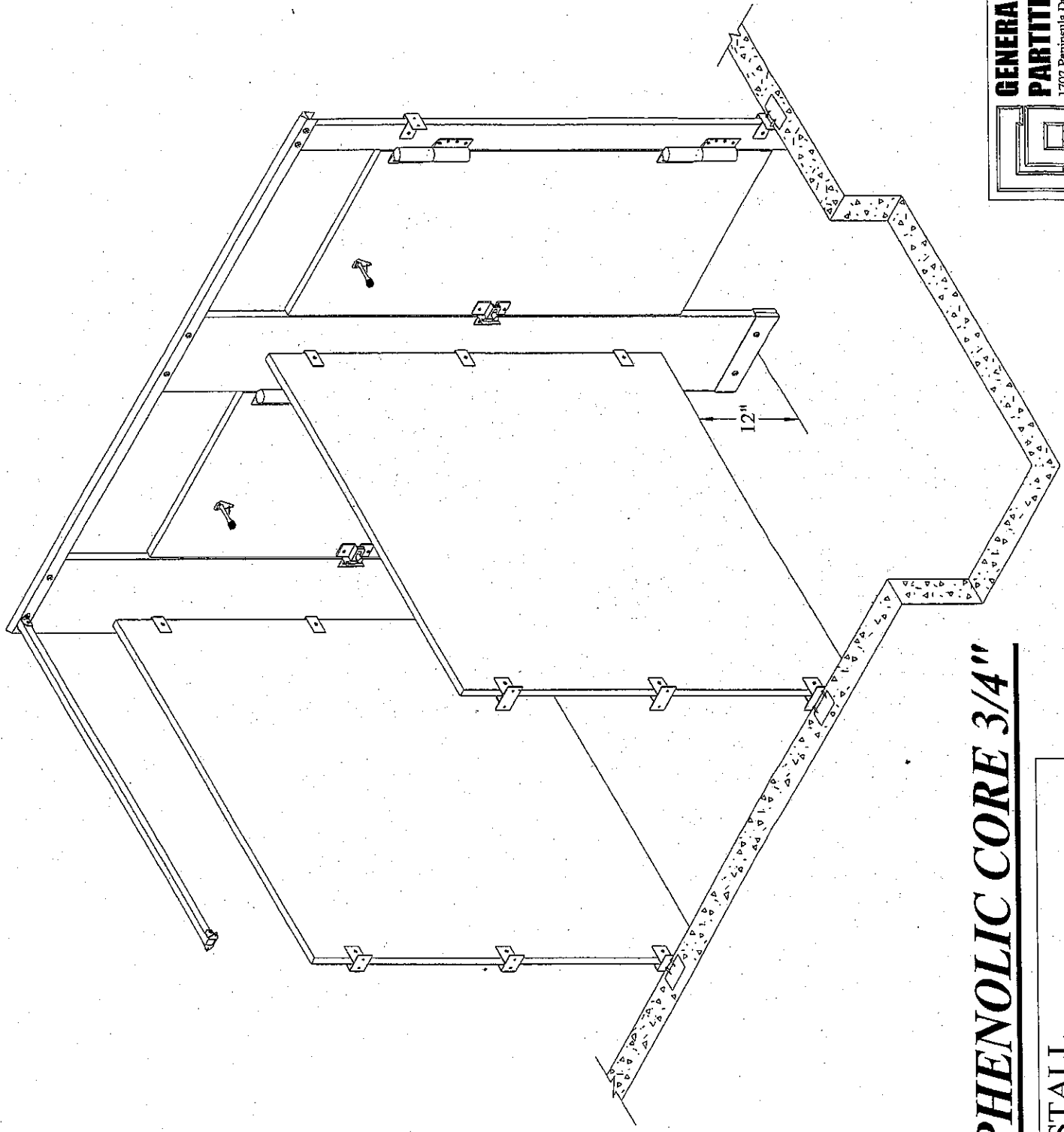

**SOLID PHENOLIC CORE 3/4"**

**STANDARD STALL  
INSTALLATION DETAIL**

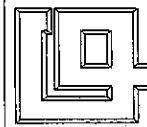

**GENERAL PARTITIONS**

*Inc. Corp.*  
1702 Perinella Drive, Erie PA  
P.O. Box 8370, Erie, PA 16505-0370  
Phone (814) 833-1134 FAX (814) 838-3473

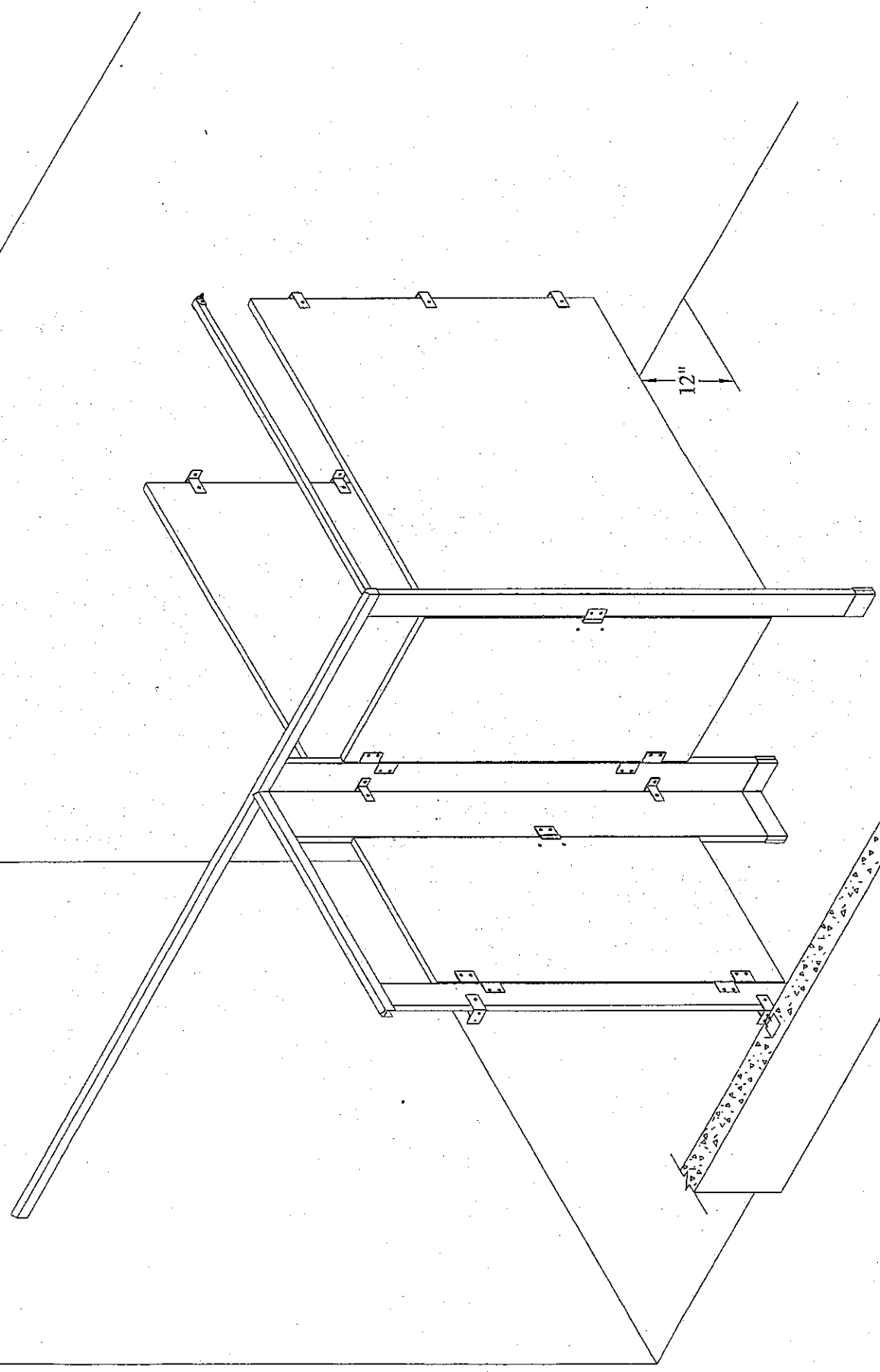

**ALCOVE WITH ADJOINING STALL  
INSTALLATION DETAIL**

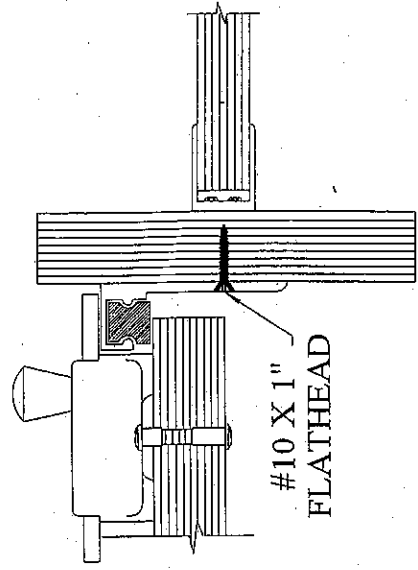

#10 X 1\"/>

OUTSWING DOOR

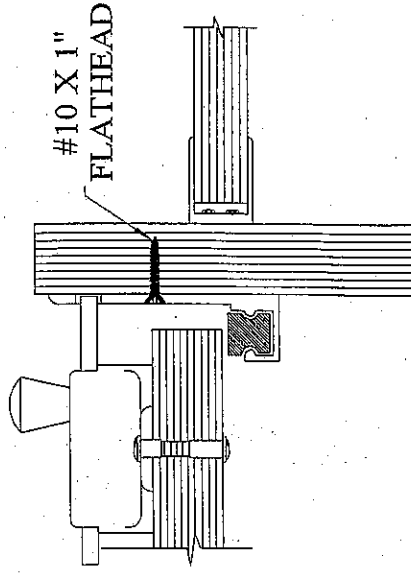

#10 X 1\"/>

INSWING DOOR

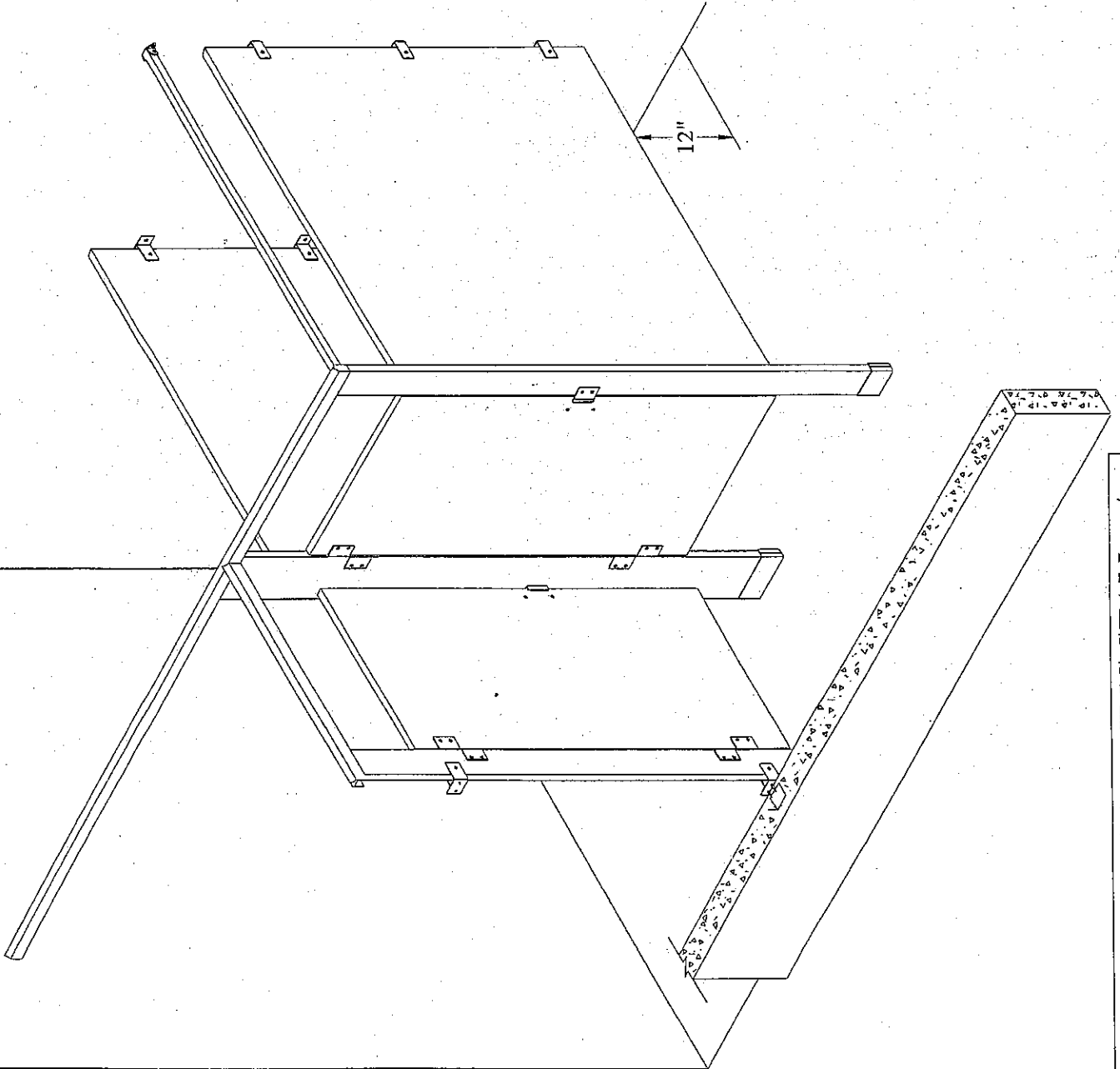

ALCOVE WITH ADJOINING STALL W/  
 FLAT STRIKE INSTALLATION DETAIL

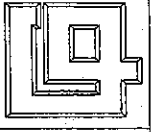

**GENERAL PARTITIONS**

Mfg. Corp.  
 1702 Peninsula Drive, Erie PA  
 P. O. Box 8370, Erie, PA 16505-0370  
 Phone (814) 833-1154 FAX (814) 838-3473

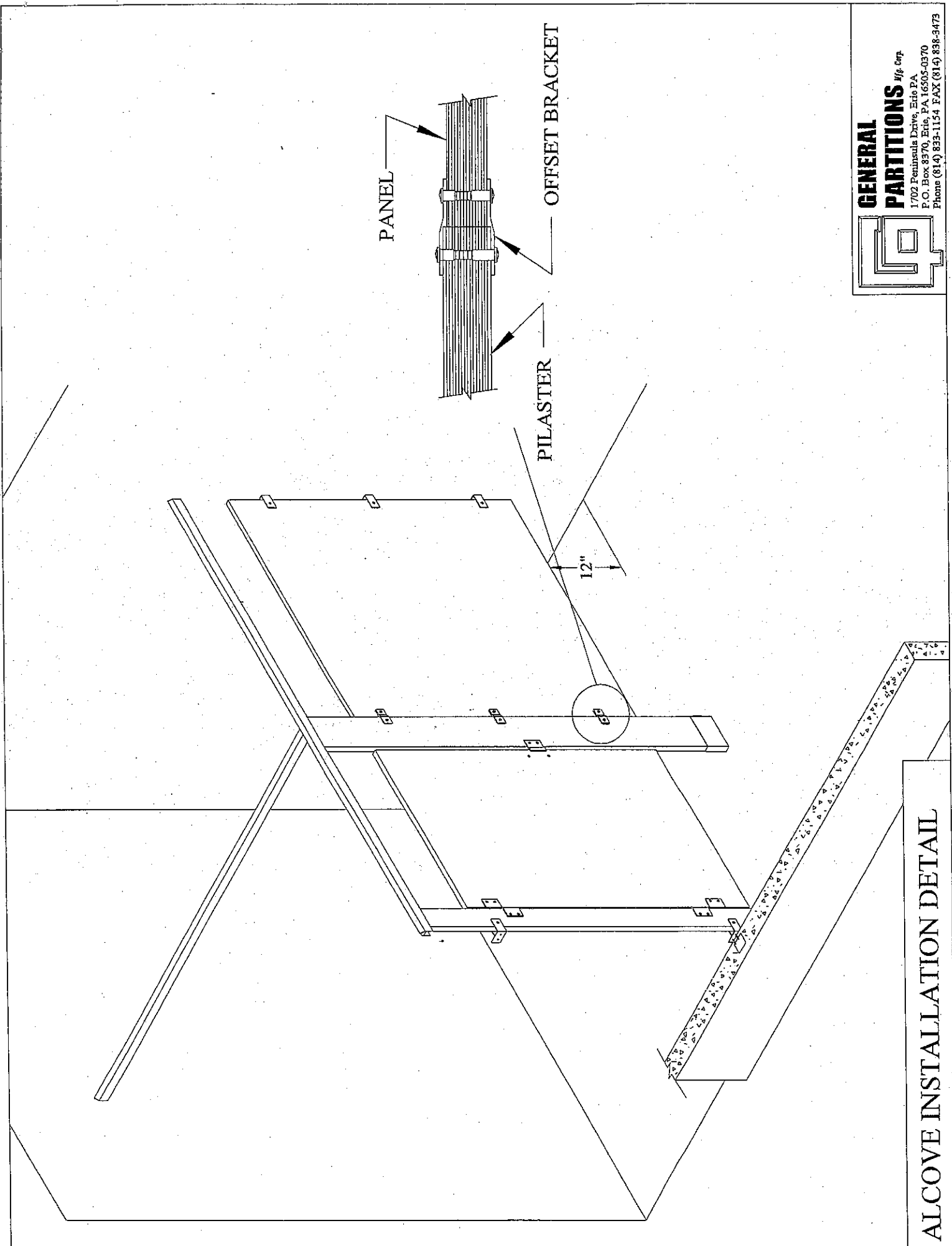

PANEL

PILASTER

OFFSET BRACKET

12"

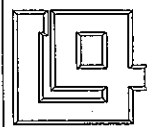

**GENERAL PARTITIONS**

*Inc. Corp.*  
1702 Peninsula Drive, Erie PA

P.O. Box 8370, Erie, PA 16505-0370

Phone (814) 832-1154 FAX (814) 838-3473

ALCOVE INSTALLATION DETAIL

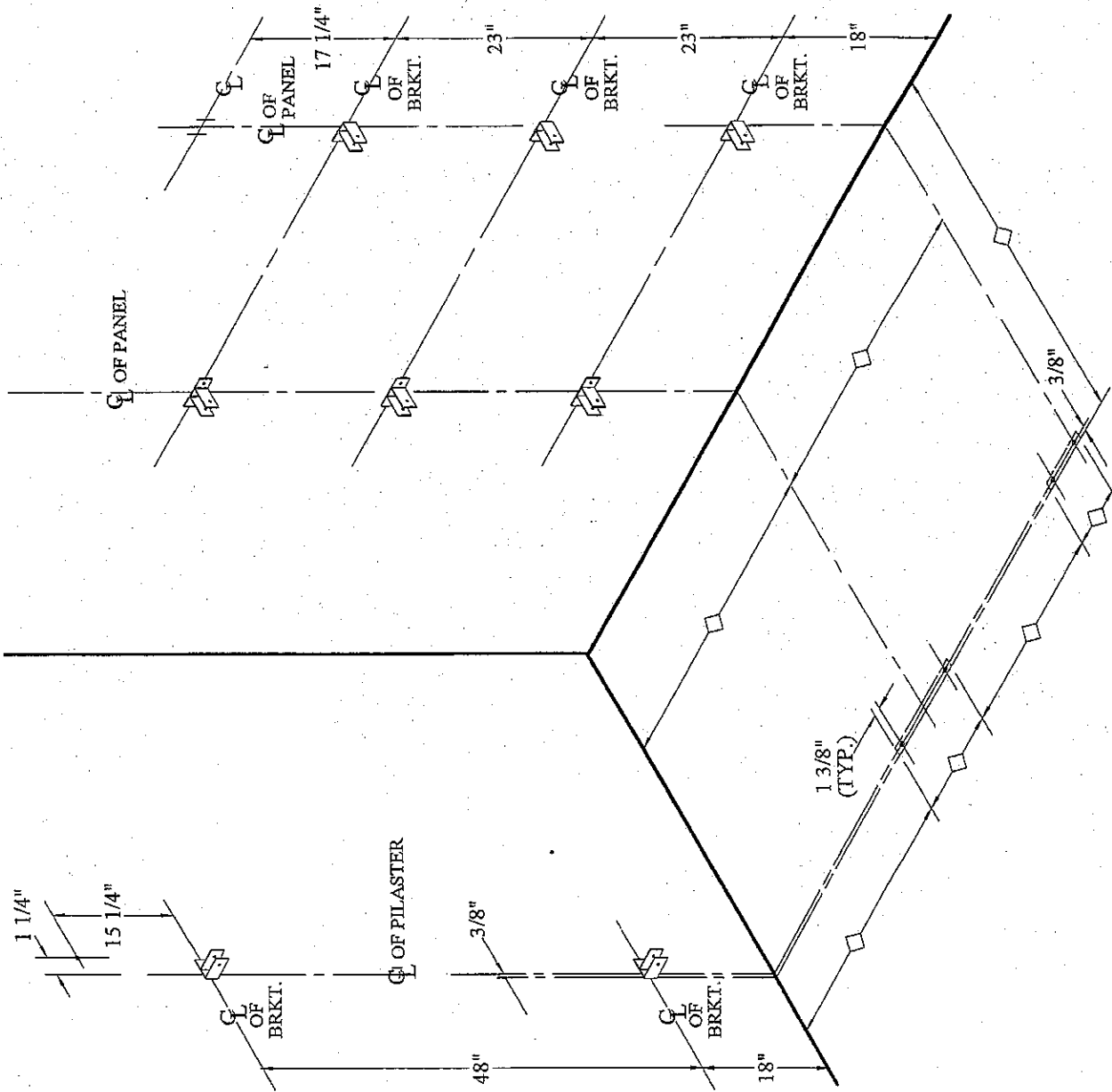

**LEGEND**

—◇— Obtain From Job Prints.

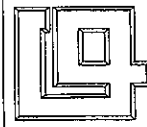

**GENERAL PARTITIONS** *Inc. Corp.*  
 1702 Peninsula Drive, Erie PA  
 P.O. Box 8370, Erie, PA 16505-0370  
 Phone (814) 833-1154 FAX (814) 838-3473

**LAYOUT AND MOUNTING BRACKETS DETAIL**

DIMENSIONS FOR DRILLING  
FLOOR FASTENERS

PILASTER SIZE	NO. OF HOLES	PIL. EDGE TO Ø OF DRILL	Ø TO Ø OF DRILL HOLES
2"	1	1"	—
3"	1	1 1/2"	—
4"	2	1 3/8"	1 1/4"
5"	2	1 3/8"	2 1/4"
6"	2	1 3/8"	3 1/4"
8"	2	1 3/8"	5 1/4"
10"	2	1 3/8"	7 1/4"
12"	2	1 3/8"	9 1/4"
14"	2	1 3/8"	11 1/4"
18"	2	1 3/8"	15 1/4"
24"	2	1 3/8"	21 1/4"

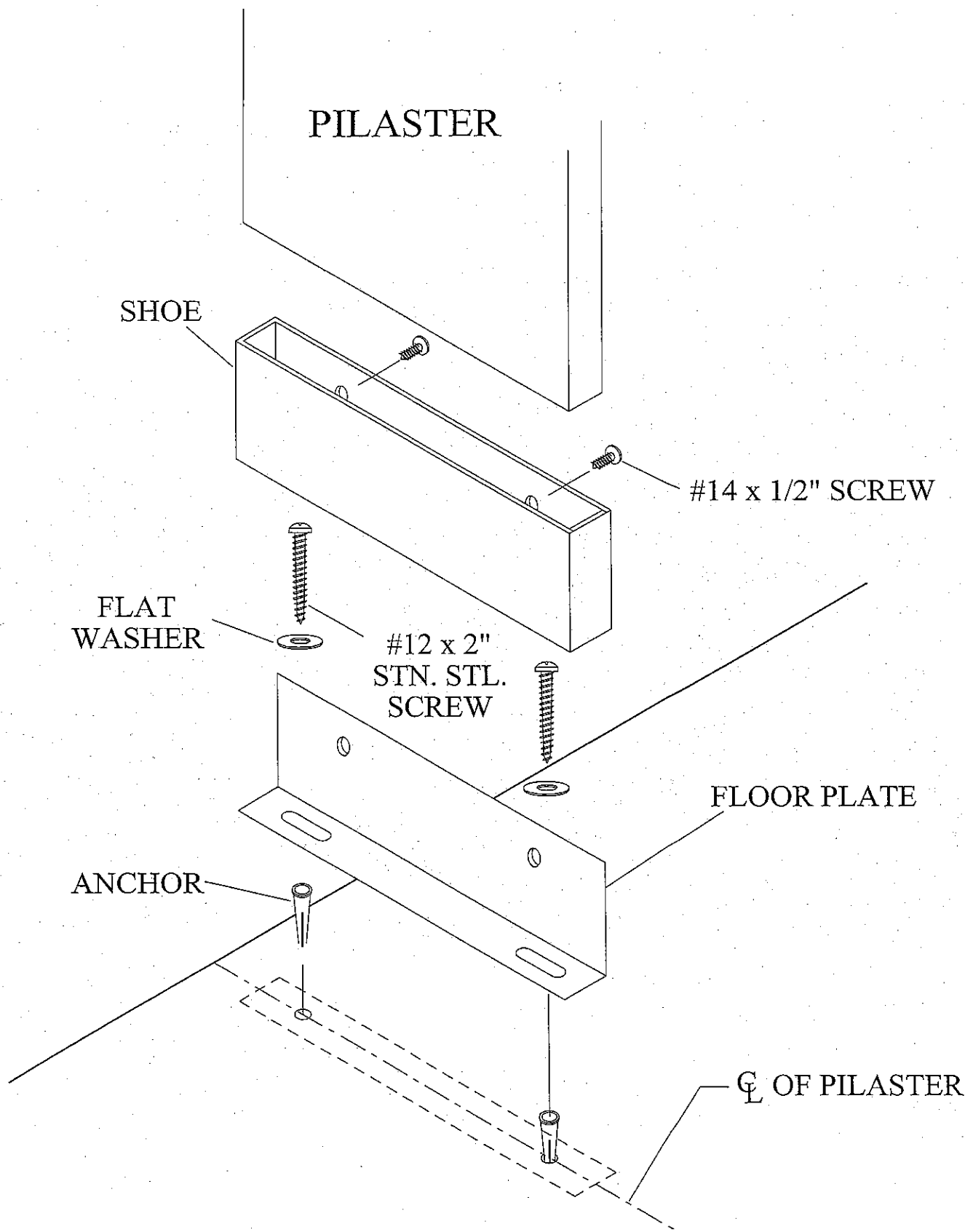

40 SERIES FLOOR CONNECTION

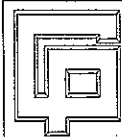

**GENERAL PARTITIONS** Mfg. Corp.  
1702 Peninsula Drive, Erie PA  
P.O. Box 8370, Erie, PA 16505-0370  
Phone (814) 833-1154 FAX (814) 838-3473

1/2" SEX BOLTS & NUT  
#14 x 1/2" STN. STL.  
TORX SCREWS

13/64" DRILL  
(TYP.)

SEE JOB  
PRINT

USE BRACKETS FOR  
HOLE TEMPLATE

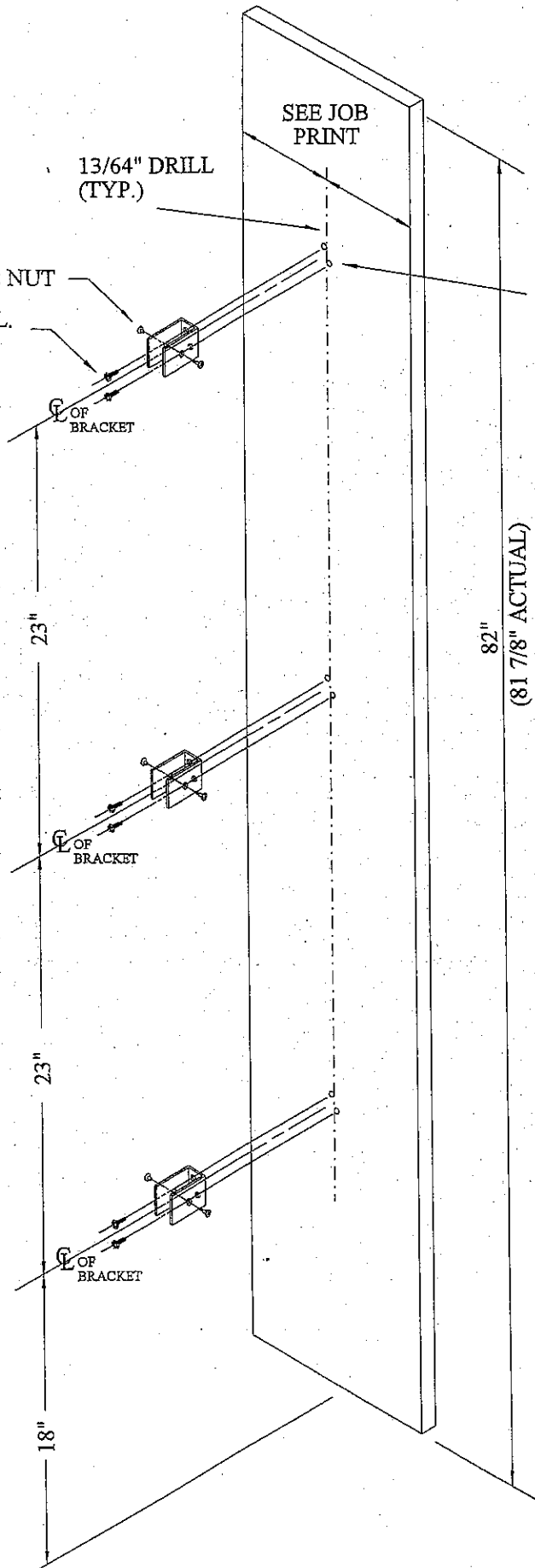

PANEL TO PILASTER  
ATTACHMENT DETAIL

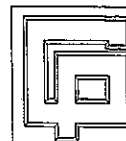

**GENERAL  
PARTITIONS** *Mfg. Corp.*

1702 Peninsula Drive, Erie PA  
P.O. Box 8370, Erie, PA 16505-0370  
Phone (814) 833-1134 FAX (814) 838-3473

#4040S ANGLE BRACKET WITH (1) #12 x 2" STN. TORX SCREW & ANCHOR PLUG @ WALL, AND (1) #14 x 1/2" STN. TORX.

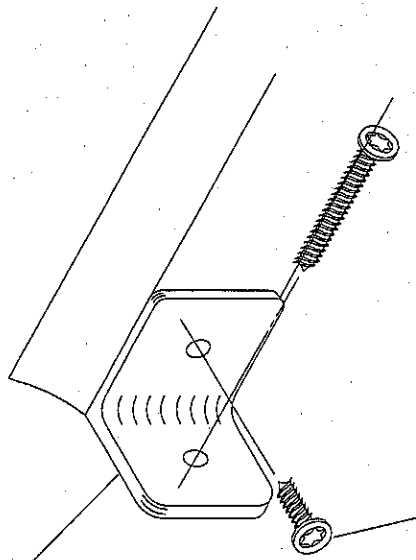

#14 x 1/2" STN. TORX SCREW

### DETAIL "A"

#12 x 2" STN. TORX SCREW

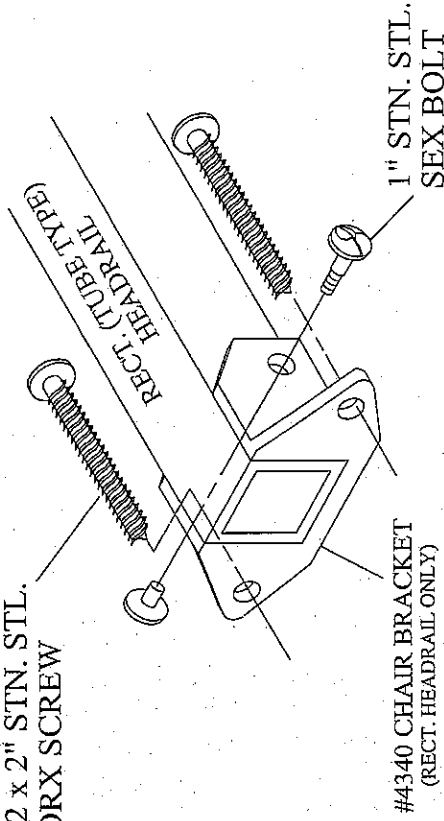

#4340 CHAIR BRACKET (RECT. HEADRAIL ONLY)

1" STN. SEX BOLT

### DETAIL "B"

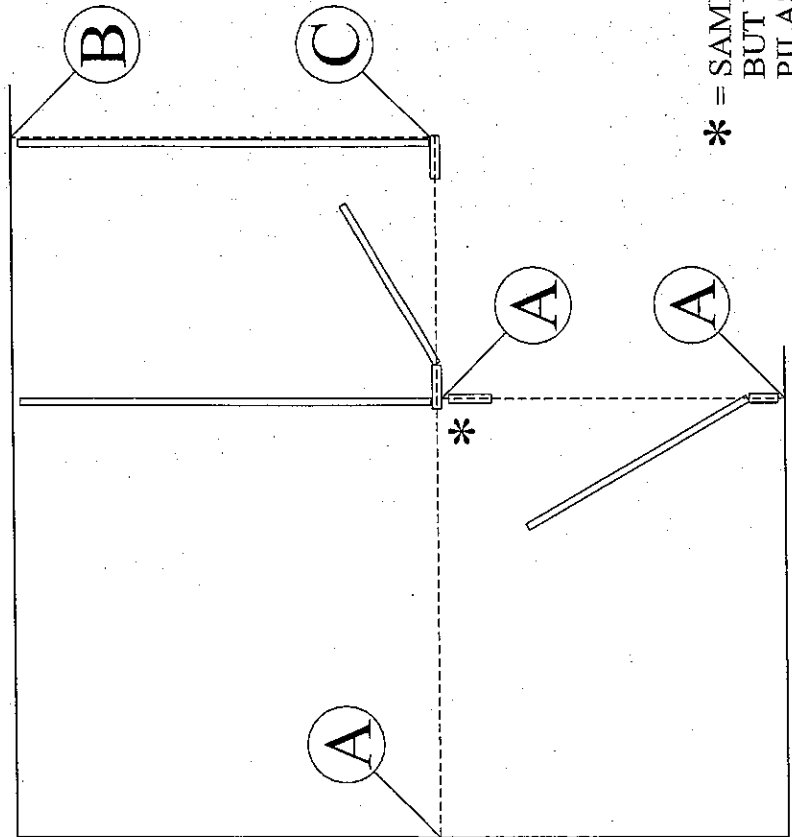

#4340 CHAIR BRACKET (RECT. HEADRAIL ONLY)

CROWN (ANTIGRIP TYPE) HEADRAIL

#14 x 1/2" - SPC

#14 x 1/2" - SPC

1" STN. SEX BOLT

### DETAIL "C"

\* = SAME CONNECTION AS DETAIL "A" BUT USE #14 x 1/2" SCREWS INTO PILASTER

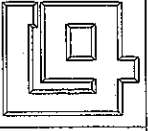

**GENERAL PARTITIONS** Corp.

1702 Peninsula Drive, Erie PA  
P.O. Box 8370, Erie, PA 16505-0370  
Phone (814) 833-1154 FAX (814) 838-3473

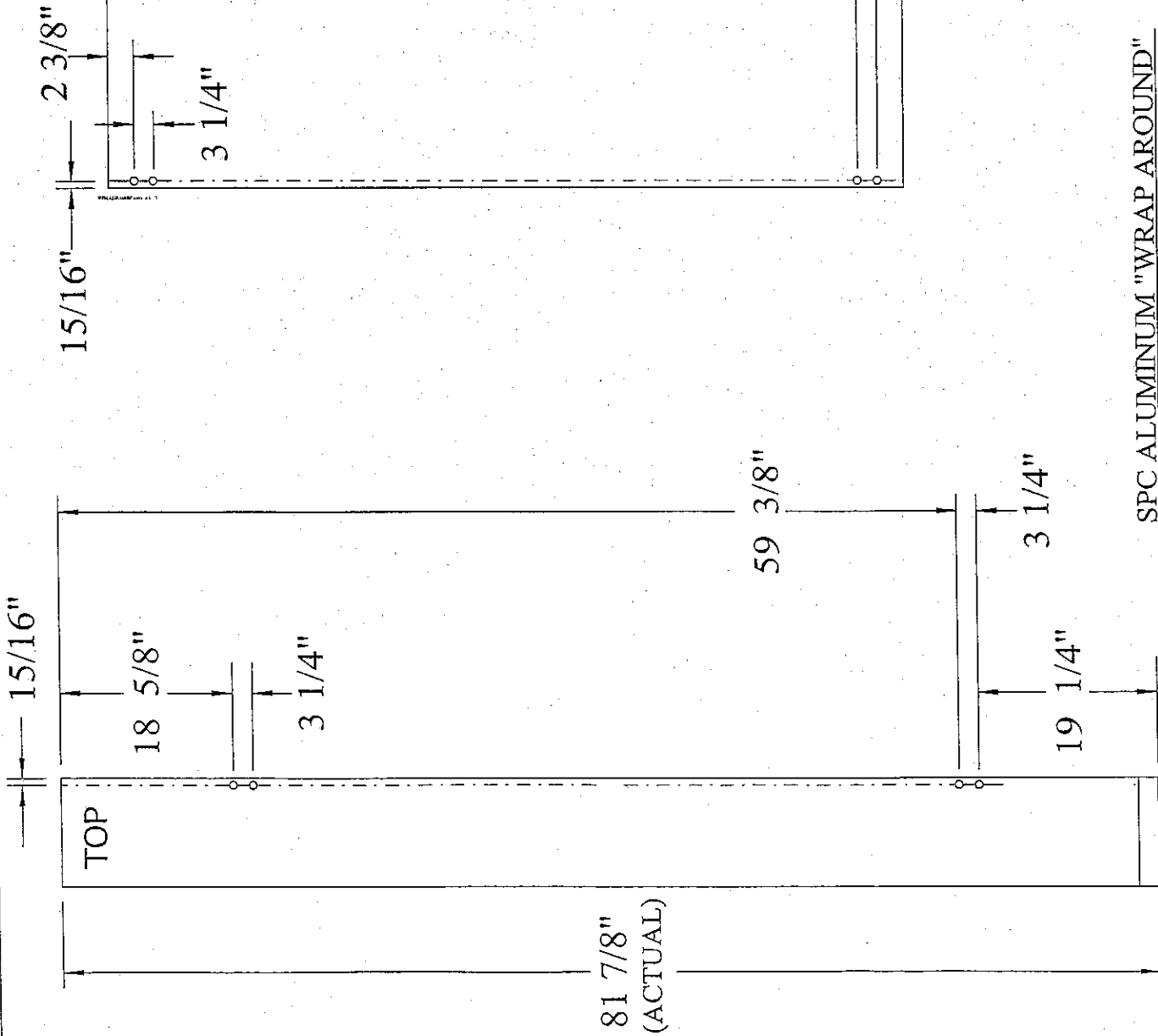

SPC ALUMINUM "WRAP AROUND"  
 #1500AL DRILLING DETAIL

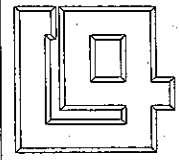

**GENERAL PARTITIONS** Inc. Corp.  
 1702 Peninsula Drive, Erie PA  
 P.O. Box 8370, Erie, PA 16505-0370  
 Phone (814) 833-1154 FAX (814) 838-3473

SERIES 40

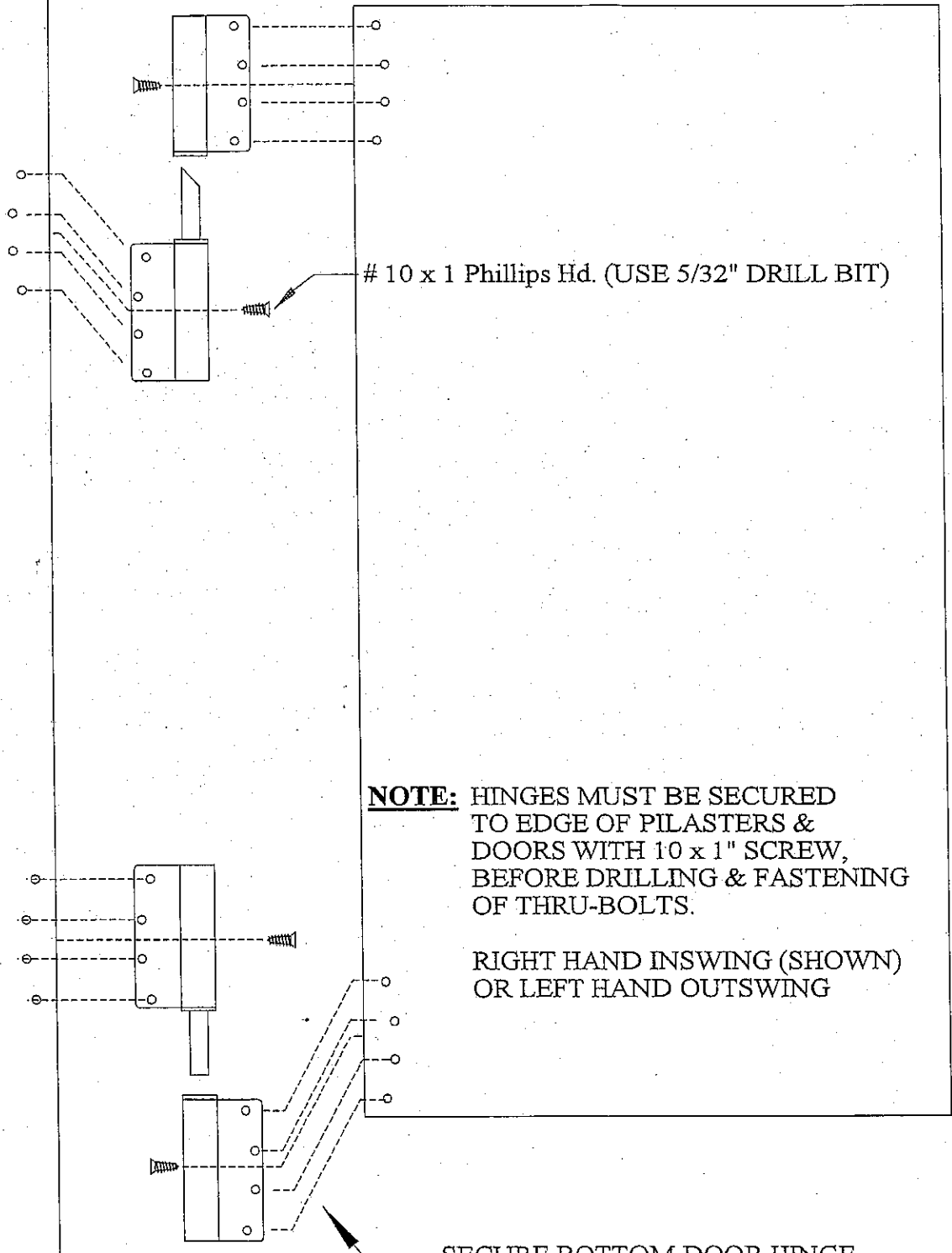

# 10 x 1 Phillips Hd. (USE 5/32" DRILL BIT)

**NOTE:** HINGES MUST BE SECURED TO EDGE OF PILASTERS & DOORS WITH 10 x 1" SCREW, BEFORE DRILLING & FASTENING OF THRU-BOLTS.

RIGHT HAND INSWING (SHOWN) OR LEFT HAND OUTSWING

SECURE BOTTOM DOOR HINGE AFTER DOOR IS HUNG ON PILASTER.

"WRAP AROUND"HINGE INSTALLATION DETAIL

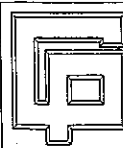

**GENERAL PARTITIONS** Mfg. Corp.  
 1702 Peninsula Drive, Erie PA  
 P.O. Box 8370, Erie, PA 16505-0370  
 Phone (814) 833-1154 FAX (814) 838-3473

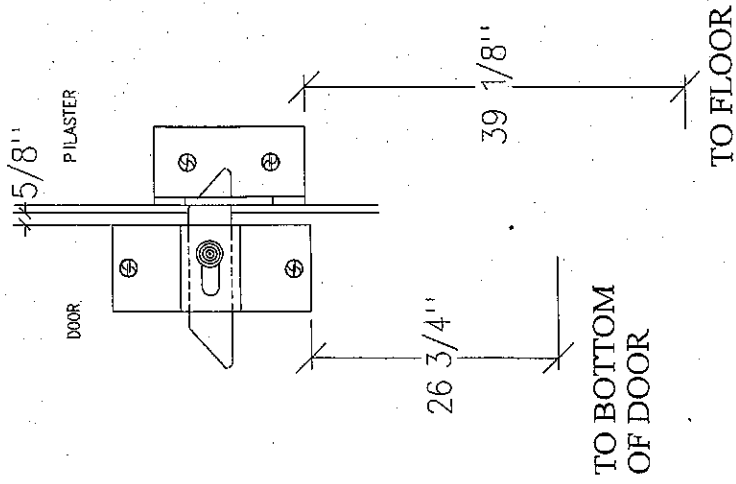

INSWING DOORS

**SLIDE LATCH & KEEPER  
MOUNTING LOCATIONS**

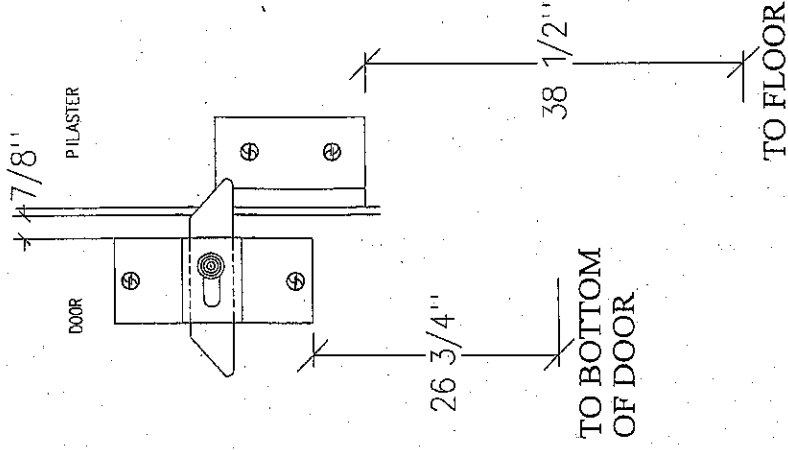

OUTSWING DOORS

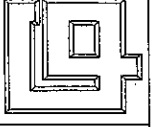

**GENERAL PARTITIONS** *Inc. Corp.*

1702 Peninsula Drive, Erie PA  
P.O. Box 8370, Erie, PA 16505-0370  
Phone (814) 833-1154 FAX (814) 838-3473

\* = DIMENSION CAN VARY TO SUIT JOB CONDITION

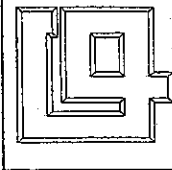
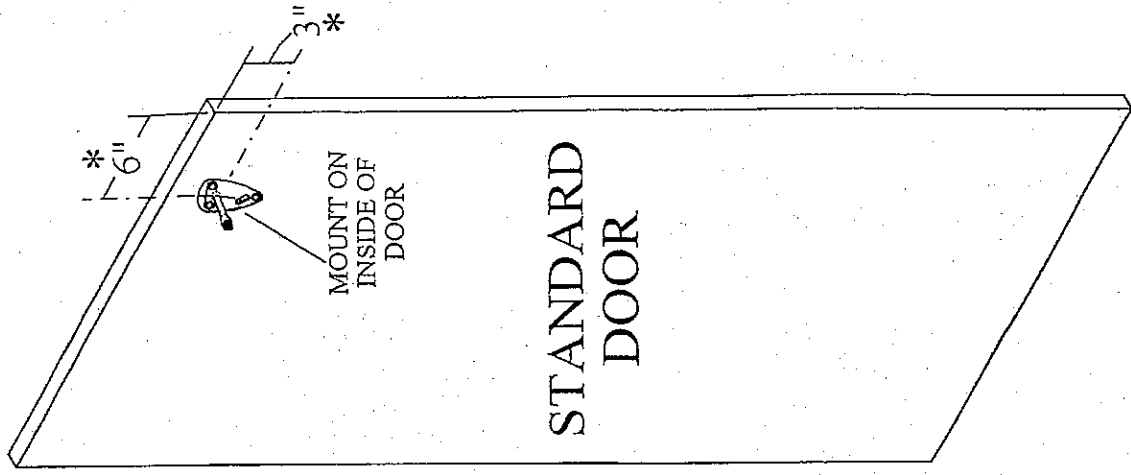
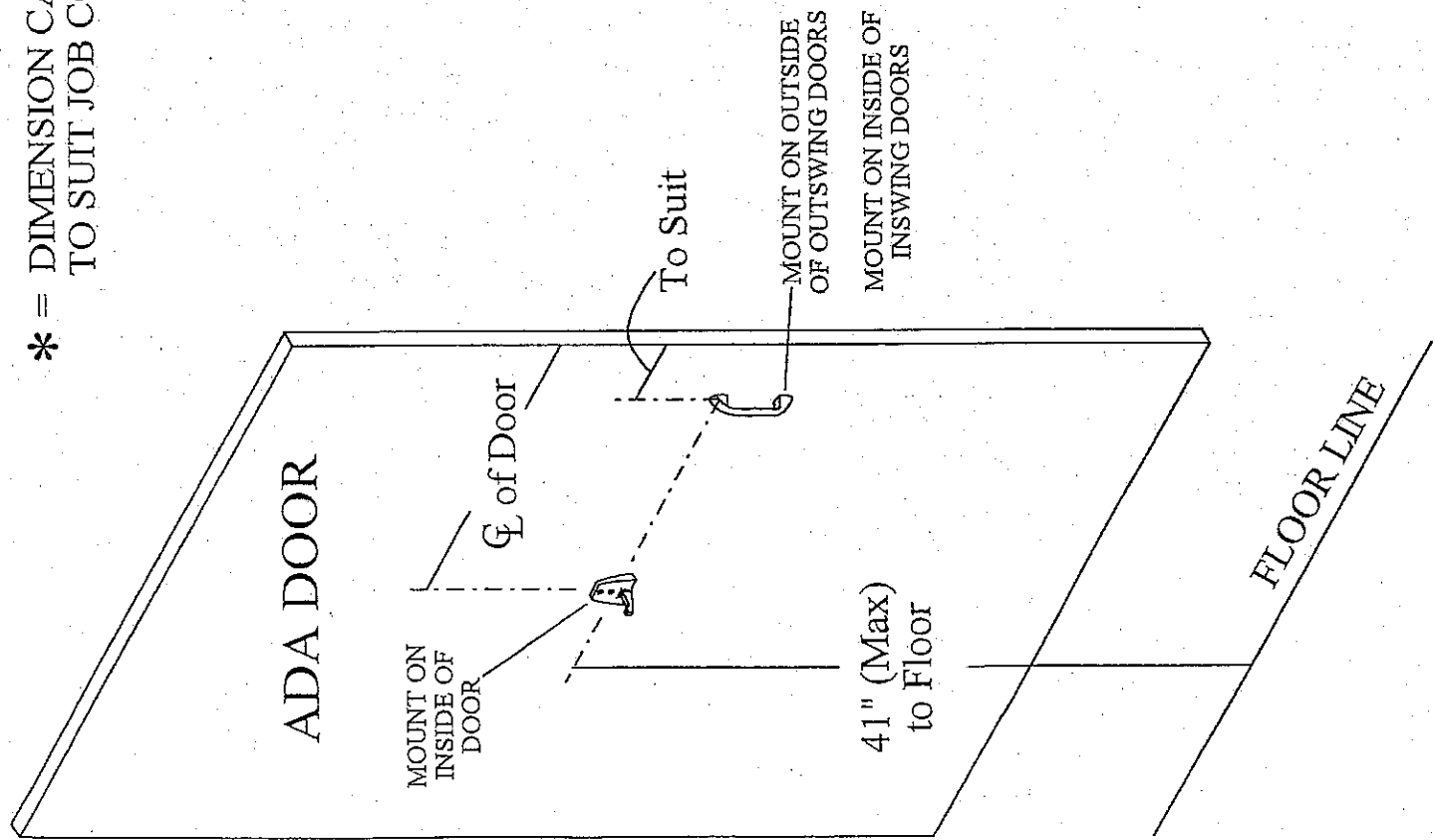

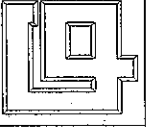
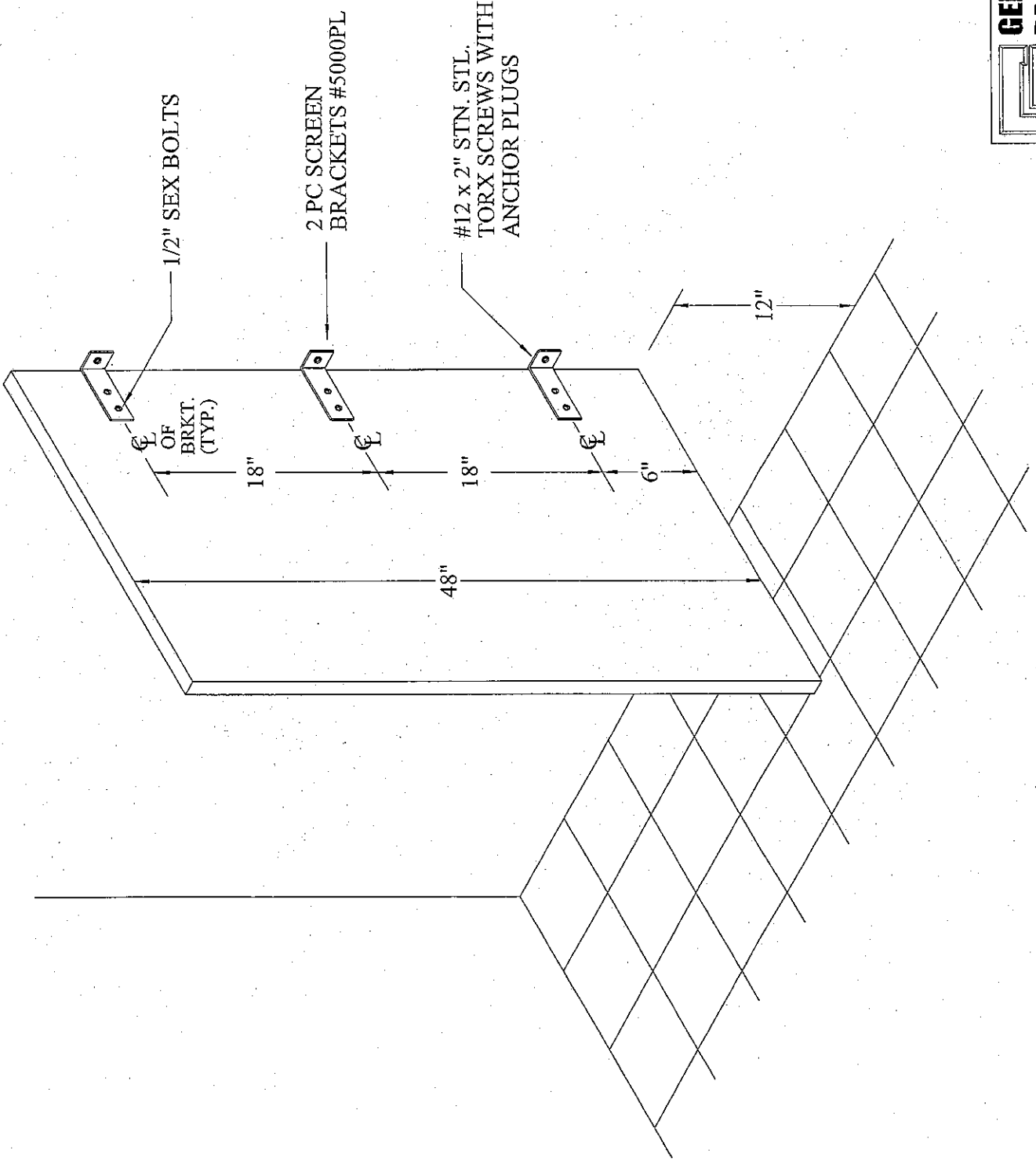

**GENERAL PARTITIONS** W/S. Corp.  
 1702 Peninsula Drive, Erie PA  
 P.O. Box 8370, Erie, PA 16505-0370  
 Phone (814) 833-1154 FAX (814) 838-3473

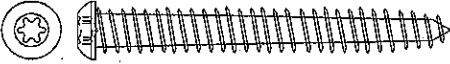
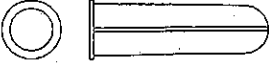
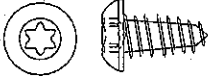
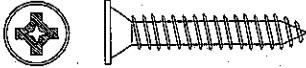
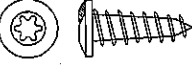
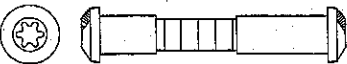

**GENERAL PARTITIONS** Mfg. Corp.  
 1702 Peninsula Drive, Erie, PA  
 P.O. Box 8370, Erie, PA 16505-0370  
 Phone (814) 833-1134 FAX (814) 838-3473

WHS-6 URINAL SCREEN DETAIL

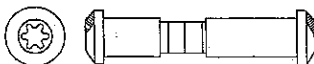
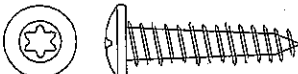
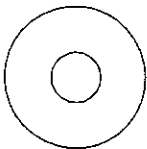
	<p>2" STAINLESS STEEL TORX HEAD #12 SCREW- used for bracket-to-wall attachment, pilaster to floor attachment and headrail bracket-to-wall attachment. Drill 1/4" hole.</p>
	<p>PLASTIC ANCHOR- used in conjunction with the 2" x #12 screws.</p>
	<p>1/2" STAINLESS STEEL TORX HEAD #14 SCREW- used for "U" brackets on back of pilasters, back of headrail at top of pilaster, pilaster shoe-to pilaster and angle bracket to anti-grip headrail. Drill 13/64" hole.</p>
	<p>1" STAINLESS STEEL #10 HINGE SCREW- used for securing the hinges to the edges of the pilasters. Drill 5/32" hole.</p>
	<p>5/8" STAINLESS STEEL #10 TORX SCREW- used for attaching the coat hook and for attachment of the wall stop on outswing doors. Drill 11/64" hole.</p>
	<p>1" STAINLESS STEEL TORX #10 THRU-BOLT- used for headrail-to-chair bracket Drill 1/4" hole.</p>
	<p>3/4" STAINLESS STEEL TORX #10 THRU-BOLT- used for brackets-to-pilaster and the following door hardware: hinges, latches, strikes and keepers. Drill 1/4" hole.</p>
	<p>1/2" STAINLESS STEEL TORX #10 THRU-BOLT- used for bracket-to-panel. Drill 1/4" hole.</p>
	<p>#14 x 1" SCREW- used for attachment of headrail block to pilaster at alcove connection. Drill 5/32" hole.</p>
	<p>1/4" x 3/4" x 1/16" STAINLESS STEEL WASHER- used for attachment of floor plate.</p>