



**GENERAL
PARTITIONS**

generalpartitions.com 



INTRODUCING

P R O D U C T G U I D E

GENERAL PARTITIONS ADVANTAGES

- ▶ A leader in the industry with **over 55 years of experience**, offering the largest selection of partitions in the industry, with 4 different styles, and 9 different types of material.
- ▶ **USA Made**—All of our products are manufactured in our union shops in Erie, PA.
- ▶ **Outstanding customer service** since its inception—**second to none!**
- ▶ Shipping schedules you can depend on—**98%** of all orders shipped within one day of the schedule date.
- ▶ Our shipments arrive to you safely with our cellular poly crate, which has proven to reduce freight damage. Statistically, **99%** of the steel orders arrived to the jobsite **damage-free**.
- ▶ Express ship allows your orders to ship as quick as **2 working days**.
- ▶ Use of TORX head fasteners with pin to prevent theft and vandalism.
- ▶ Barrier free design and operational handles to meet ADA requirements.

PROJECTS THAT WE ARE PROUD TO BE PART OF

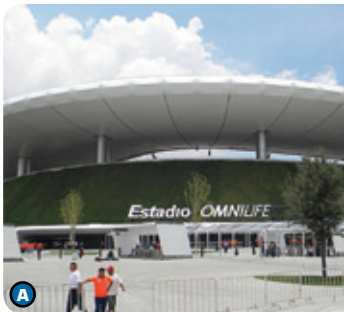

Juan Olivas

Estadio-Chavis: Chivas Soccer Stadium— Guadalajara

680 compartments: Combination of 40 and 50 floor mounted/overhead braced, and ceiling hung.
Material: Anti-Graffiti Powder Coated Steel, Stainless Steel and Solid Phenolic Core



David Fulmer

Boston Convention Center

250 Compartments: Series 60 floor to ceiling.
Material: Stainless Steel



Greg West

Pentagon Wedge 1

240 Compartments: of Series 40 floor mounted/overhead braced
Material: Solid Phenolic Core

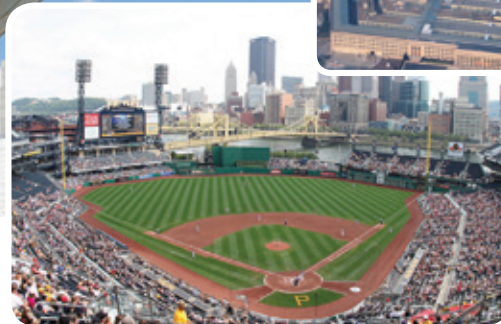

Rob Pongsajapan

PNC Ballpark

280 Compartments: of Series 40 floor mounted/overhead braced.
Material: Powder Coated Steel

PARTITION STYLES

30 SERIES

Where no overhead bracing is required, but ceiling hung partitions are impractical. General Partitions' 30 series (floor supported) is ideal. Modern spaciousness and rigidity are important features. **The 30 Series is also featured in a 54" "Junior Size" which has proved to be a great help with younger children.**



40 SERIES

Our most popular style of toilet compartment construction is 40 Series (floor supported with headrail.) It is recommended for new and old buildings where economy, ease of installation, and rigid overhead bracing are required.

50 SERIES

The ease of floor maintenance when General Partitions 50 Series (ceiling hung) style is used, has influenced architects and building owners to utilize this style particularly on construction where dropped ceiling or open span type construction is practical.



60 SERIES

General Partitions' floor to ceiling Series 60 is recommended for all areas subject to heavy usage. For problem areas we recommend the use of full length aluminum brackets and hinges.



EASTERN STYLE

When increased privacy is required **"Eastern style" is an option that can be incorporated into any of our partition series and materials when privacy is a concern** *Panels and doors are specified as 67" high and mounted 3-1/2" off of the floor **"Eastern max style" can also be incorporated into any series and material of partitions when maximum privacy is required.** *Panels and doors are specified as 72" high and mounted 3-1/2" off of the floor *Continuous brackets and no sight door options to minimize any sight gaps are available as add-ons to either Eastern Style.



POWDER COATED STEEL



**ANTI GRAFFITI
OPTION AVAILABLE.**

Fireproof steel partition will not support a flame or produce toxic gases.

Express shipment will ship in 2 working days. Some restrictions apply. Our complete color chart is available upon request.



SW-237
Almond

SN-548
Tan

SN-336
Sand



SR-485
Mauve



SR-415
Admiral Blue



SA-386
Fashion Grey



SB-382
Cadet Blue



SI-567
Hunter Green



SO-715
Burgundy



SA-401
Mist Grey



SR-118
Terra Cotta



SR-455
Red



SN-409
Autumn Brown



SN-248
Royal Beige



SI-575
Teal



E-36
Black



SW-20A
White



SV-936
Silver Vein



WV-852
White Vein

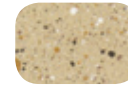

SS-338
Sandstone



GS-403
Greystone

POWDER COATED & STAINLESS STEEL CONSTRUCTION & DETAILS

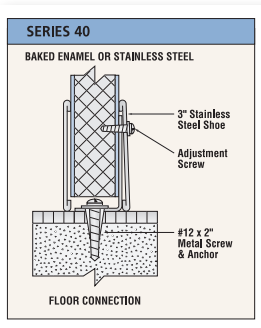

CONSTRUCTION

General's standard panel with Ribcore sound deadening reinforcement is offered as a standard at no extra charge. Sheet metal skins are bonded under pressure, to each cell of the core with an adhesive impervious to moisture. Lighter weight, greater strength and permanently flat panels are provided through this type of construction.

Material Overview:

General's Powder Coated Galvanized Bonderized Steel is available in all styles for toilet partitions, showers and dressing compartments. The economy and durability of Powder Coated Steel makes it the popular choice for new construction or remodeling.

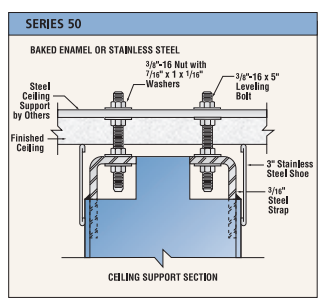

CORNER REINFORCEMENTS

Used on all steel partitions at exposed corners. Mechanically fused to the edges. Doubles the strength of the corner. Also allows field repairs if and when required. Eliminates welding and grinding of the corners which removes the protective zinc coating.

GREEN ALERT

Environmentally safe—our Hybrid Polyester—Epoxy powder contains no harmful solvents or VOC's applied electrostatically and baked in an energy efficient infrared oven to cure. **Contains post consumer and post industrial recycled steel and may contribute to LEED Certification.**



STAINLESS STEEL

Stainless Steel is not only a good selection for strength and durability, but is an architecturally pleasing addition to any decor. Available in Satin, or a variety of textures and patterns.

- ▶ Fireproof steel partition will not support a flame or produce toxic gases.

TEXTURED STAINLESS STEEL

The partitions are fabricated with a deep textured finish, and offer the following advantages:

- ▶ Vandal Resistant
- ▶ Resists Fingerprints and Smudges
- ▶ Reduces Maintenance Costs
- ▶ Guaranteed 15 Years



Material Overview:

General's stainless steel is available in all styles for toilet partitions, showers and dressing compartments. **Stainless steel, the deluxe steel partition material is easily cleaned and will hold it's beauty for years.** Dirt, grease and cosmetics are easily removed. Even scratches can be eliminated by buffing the finish and blending the surface.

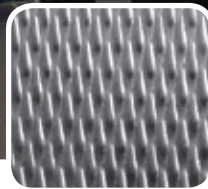

Diamond Pattern



Leather Pattern

Satin finish shown

GREEN ALERT

- ▶ No VOC's
- ▶ Contains post consumer and post industrial recycled steel and may contribute to LEED Certification.
- ▶ Stainless Steel is 100% recyclable.



POWDER COATED & STAINLESS STEEL CONSTRUCTION & DETAILS

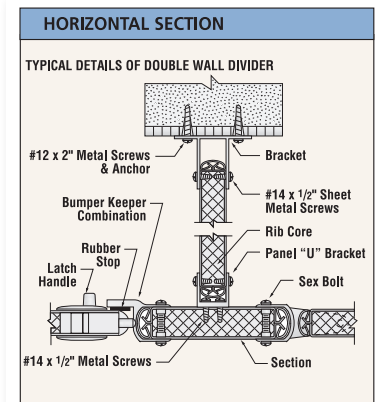
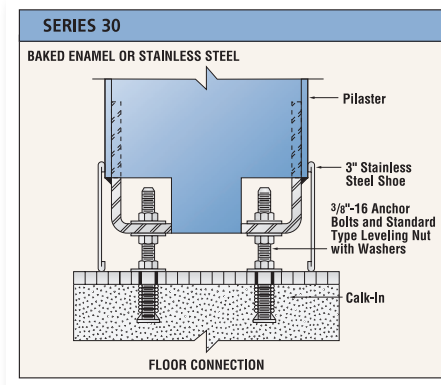

HIGH DENSITY POLYMER

STANDARD

- ▶ Heavy duty 8" wraparound hinges and continuous aluminum brackets at all locations adds strength and durability
- ▶ Graffiti resistant
- ▶ 25 year guarantee

OPTIONS:

- ▶ Continuous plastic brackets and shoes
- ▶ Integral and continuous hinges
- ▶ No sight strike
- ▶ Also available to meet NFPA 286 Classification as well as ASTM E 84 Class A & B

Express shipment will ship in **2 working days—some restrictions apply.** Our complete color chart is available upon request.



**NOW
NFPA 286
FIRE RATED
OFFERED**



205
Galaxy



220
Cobalt



225
Designer White



228
Linen



236
Sterling



238
Oyster



240
Colonial



242
Titanium



250
Onyx



260
Sandstone



262
Latte



264
Coffee



272
Fern



274
Hunter



290
Bordeaux



295
Cranberry



601
Topaz



604
Limestone



605
Granite

Material Overview:

General's H.D.P. toilet partitions, showers and dressing compartments are manufactured using high density polymer resin. Color is solid thru-out. Compartments will not rust, rot delaminate or absorb odors like marble. Water resistant, can be used under any moisture condition. Perfect for shower and dressing compartments as well as toilet partitions.

GREEN ALERT



- ▶ We recycle all waste and scrap during our manufacturing process.
- ▶ We use reclaimed material in our production.
- ▶ Our HDP sheets are completely 100% recyclable.
- ▶ We also have 100% post consumer HDP partitions available.

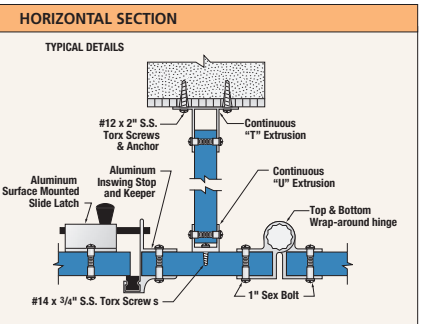

SOLID PHENOLIC CORE

General's S.P.C. toilet partitions, showers and dressing compartments are fabricated of solid phenolic core with matte finish high pressure melamine fusion welded to surface of core to form a one piece unit which will not delaminate, edges are black solid phenolic resin. **Completely water resistant, impervious to steam, soaps and detergents. Will not mildew.**

Express shipment will ship in 2 working days—some restrictions apply. Our complete color chart is available upon request.



D30-60
Natural
Almond



D381-60
Fashion Grey

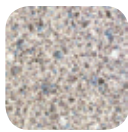

4142-60
Grey Glace

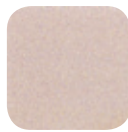

D79-60
Haze



4623-60
Graphite
Nebula



4669-60
Natural Tigris

GREEN ALERT

- ▶ SFI Certified
- ▶ GreenGuard Certified
- ▶ May contribute to LEED Certification



COLOR-THRU SOLID PHENOLIC CORE

Color-Thru Solid Phenolic Core Panels offer all the strength and durability of our black core phenolic, with the added advantage of consistent matching color throughout the core, forming a one piece panel which will not delaminate. Excellent choice for high traffic areas. The Color-Thru Phenolic carries all the same specs and hardware as our standard black core SPC.

ADVANTAGES

Toilet Partitions offering all of the dependability of Phenolic, but adds the advantage of being color consistent throughout the thickness of the partition. It continues to be completely water resistant, impervious to steam, soaps, and detergents.

STANDARD PRODUCT HIGHLIGHTS

- ▶ Extremely tough surface
- ▶ Core color extends all the way through the product
- ▶ Class A fire rated

COLOR OPTIONS



Brick



Clay



Olive



Khaki

PLASTIC LAMINATE



General's plastic laminates are available in all styles for toilet partitions and dressing compartments. **Plastic laminate material is easily cleaned and can't rust. Dirt, grease and cosmetics do not penetrate the durable plastic surface which is highly resistant to scratches.**

Express shipment will ship in 2 working days. Other colors ship in 10-15 days—some restrictions apply. Our complete color chart is available upon request.



D381-60*
Fashion Grey



D30-60*
Natural Almond

GREEN ALERT

- ▶ Laminate sheets contain post industrial recycled material and are GreenGuard Certified.
- ▶ Wood core min 91% recycled material with third party certification—SCS, EPP.
- ▶ May contribute to LEED Certification.

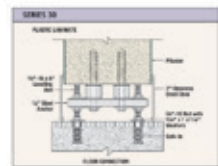
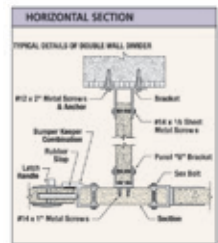
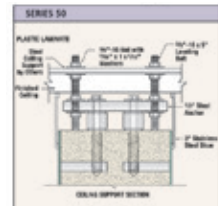
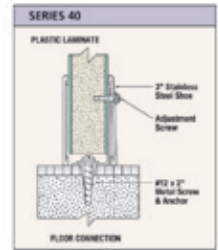

FIBERGLASS REINFORCED PLASTIC

General's F.R.P. toilet partitions, showers and dressing compartments start with a highly durable, graffiti resistant FRP surface, and bond it to a wood core. **The final product is a tough stain resistant partition system that will not dent, rust, corrode, or delaminate.**

Our complete color chart is available upon request.

OPTIONS:

- ▶ Full length brackets and hinges
- ▶ Stainless Steel Hardware

FRP COLORS:

- ▶ Graffiti resistant texture finish
- ▶ Hard Durable Surface



FR-437
Almond



FR-250
Black

GREEN ALERT

- ▶ Wood core min 91% recycled material with third party certification — SCS, EPP.
- ▶ May contribute to LEED Certification.
- ▶ Formaldehyde free



SOLID PLASTIC HDP LOCKERS

General Partitions solid plastic locker is constructed of a one-piece HDP body with no mechanical fasteners or hardware.

The locker frame is attached using full length dado joints secured by continuous plastic welds. The continuous spring-loaded latch mechanism provides a vertical lift that is designed to accept a padlock. The latch mechanism is attached to the length of the door, providing a continuous, secure latch.

Our Door Hinge is also continuous and contains no metallic knuckles or pins. Solid Plastic benches with pedestals available to match the lockers.

- ▶ Solidly Constructed of High Density Polymer
- ▶ Perfect for High Moisture Areas
- ▶ Will not Rust, Rot, Dent or Corrode
- ▶ 20 Year Limited Warranty



- ▶ We recycle all waste and scrap during our manufacturing process.
- ▶ We use reclaimed material in our production.
- ▶ Our HDP sheets are completely 100% recyclable.

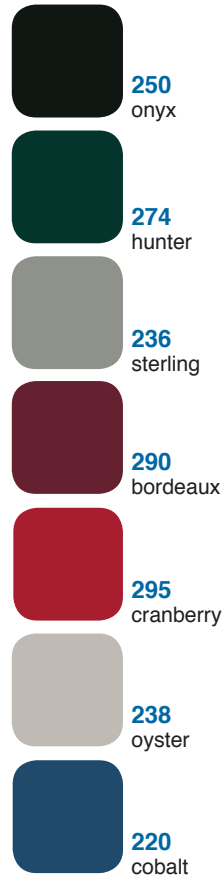

AVAILABLE SIZES

A = 12", 15", or 18"
 B = 12", 15", or 18"
 C = 24", 36", 48", 60", or 72"

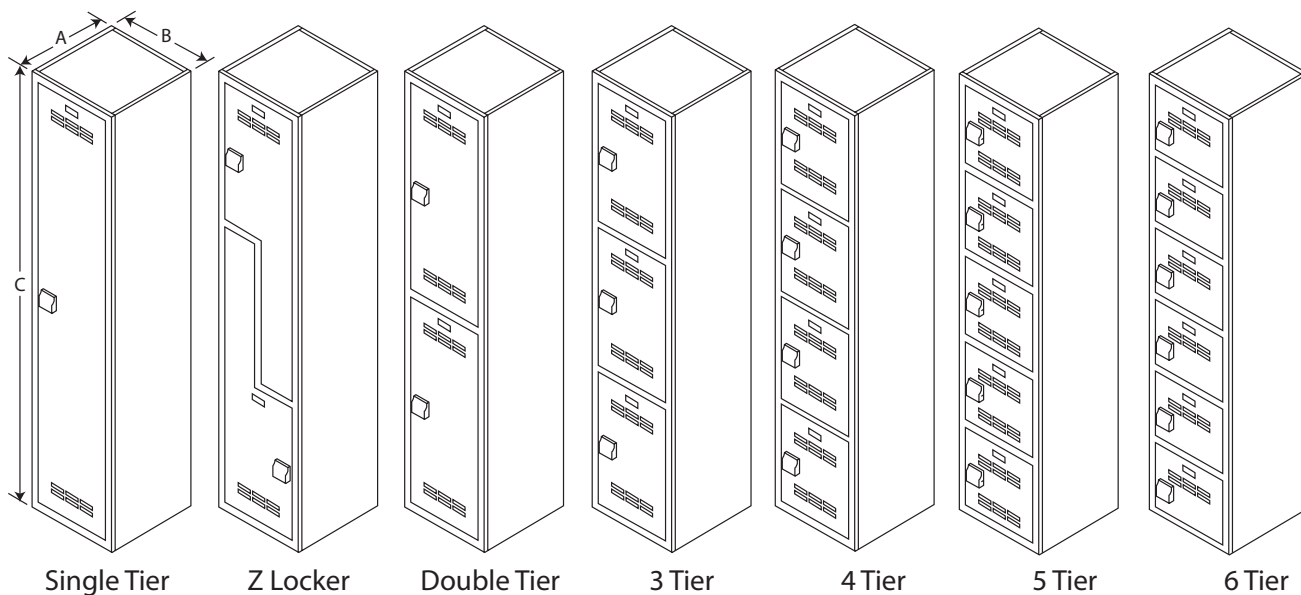

GENERAL

URINAL SCREENS

Wall Hung (WHS)

Screen is 1" thick insulated panel sealed with locking bar and mitered corner reinforcements. Hung from three chrome-plated "T" brackets.

- WHS-1 Powder Coated galvanized and bonderized steel.
- WHS-3 Stainless steel panel.
- WHS-4 Plastic Laminate - High Pressure Laminate.
- WHS-6 Solid Phenolic Core (1/2" thick panel).
- WHS-10 Fiberglass Reinforced Plastic

Floor Braced Screen (FBS)

Screen is 1" thick insulated panel supported by a floor supported pilaster (see Series 30 specification).

- FBS-1 Powder Coated galvanized, bonderized steel.
- FBS-3 Stainless steel.
- FBS-4 Plastic Laminate—High Pressure Laminate
- FBS-6 Solid Phenolic Core (1/2" thick panel - 3/4" thick pilaster).
- FBS-7 High Density Polymer
- FBS-10 Fiberglass Reinforced Plastic

Floor Supported With Headrail (FSH)

Headrail braced 1" thick double-wall panel (see Series 40 specification). Panel set into extra-heavy wall extruded aluminum pilaster. Stainless steel floor shoe.

- FSH-1 Powder Coated galvanized, bonderized steel panel and integrated extruded aluminum pilaster.
- FSH-3 Stainless steel panel with integrated painted rustproof, aluminum pilaster.
- FSH-4 Plastic Laminate—High Pressure Laminate 40 Series Pilaster attached to panel with chrome-plated offset brackets thru bolted.
- FSH-6 Solid Phenolic Core (1/2" thick panel—3/4" thick pilaster). Pilaster attached to panel.
- FSH-7 High Density Polymer. Pilaster attached to panel.
- FSH-10 Fiberglass Reinforced Plastic. Pilaster attached to panel.

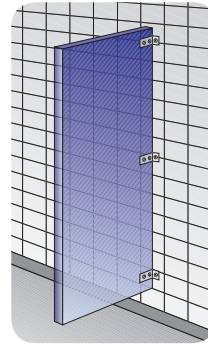

Wall Hung (WHS)

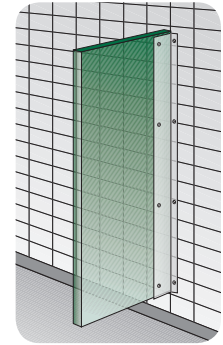

Wall Hung (WHS) (Shown with optional flange)

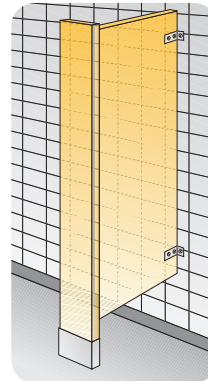

Floor Braced Screen (FBS)

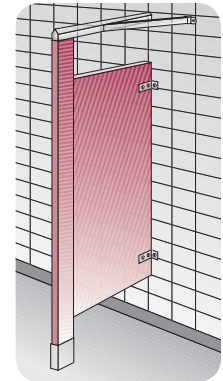

Floor Supported with Headrail (FSH)

SHOWER CABINETS AND PARTITIONS

General's shower cabinets are available in standard sizes and in finishes to match toilet and dressing compartments. They may be used in units or battery-type installations for institutional projects such as schools, dormitories, clubs, hospitals or industrial buildings.

SHOWER CABINETS

General Partitions' shower is the finest in double-wall unit shower construction. It features a pre-cast terrazzo receptor. Available sizes—32" x 32" x 82", 36" x 36" x 82", 40" x 40" x 82" Neocorner, 40" x 40" x 82" or 40" x 48" x 82" Handicapped.

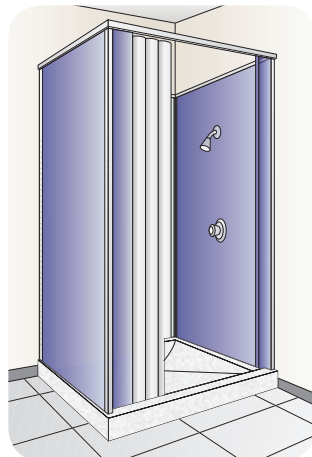
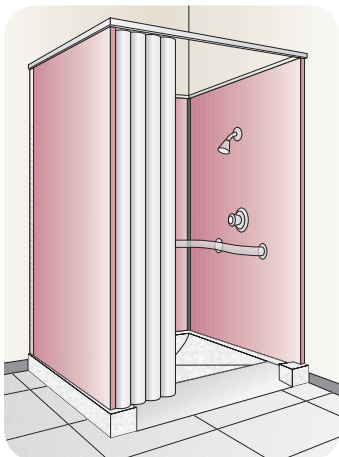

Physically Handicapped Accommodations

SHOWER/DRESSING COMPARTMENTS

Available in Powder Coated, Stainless steel, F.R.P. (Fiberglass Reinforced Plastic), S.P.C. (Solid Phenolic Core), HDP (High Density Polymer). The S.P.C., HDP, material is non-absorbent, completely water resistant, impervious to steam, soaps and detergents and will not mildew. These features, coupled with the finest hardware available, makes an unbeatable combination.

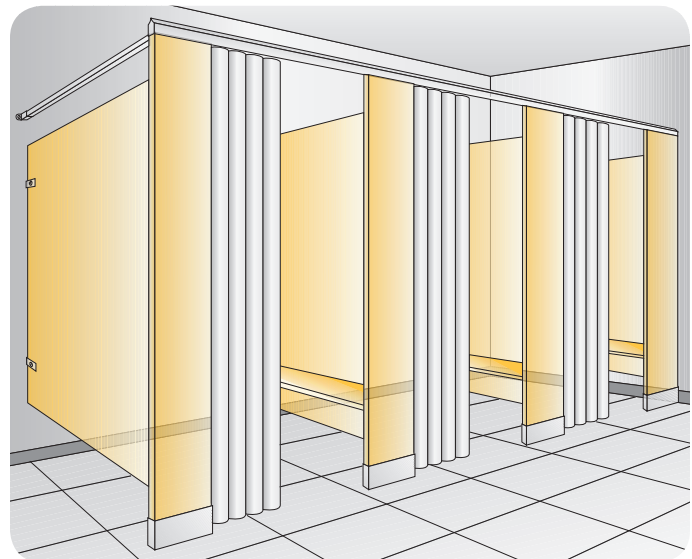

SPECIFICATIONS

POWDER COATED STEEL

Scope—All powder coated toilet partitions shall be (indicate one or more style numbers as required) 30, floor supported; 40, floor supported with headrail; 50, ceiling hung; 60, floor to ceiling; as manufactured by General Partitions Mfg. Corp., Erie, Pennsylvania.

Panel—Double-Wall Construction—Shall be 1" thick with two sheets of galvanized and bonderized steel bonded together before attaching die drawn molding on all four sides of panels. Mitered reinforcements fused to corners for added structural strength. Filler shall be General's Ribcore sound-deadening insulation.

Doors—To be same construction as panels with galvanized and bonderized steel.

30 Series—Pilasters—Shall be 1-1/4" thick with two sheets of level galvanized and bonderized steel, bonded before attaching die drawn molding to sides and top, mitered reinforcements fused on both corners for added structural strength. Same construction as panel. Pilasters are to be anchored to floor with standard 3/8" threaded rod, hex nuts and washer to provide vertical adjustment and necessary strength.

40 Series—Pilasters—Shall be 1-1/4" thick with two sheets of galvanized and bonderized steel, bonded before attaching die drawn molding to sides. Same construction as panel. Pilasters are to be anchored to floor with heavy gauge angle. Top of pilasters to be securely braced with extruded aluminum headrail with integral crown loafer rail.

Headrail—To be integral crown loafer rail, extruded aluminum heat-treated and anodized with necessary fittings.

50 Series—Pilasters—Shall be 1-1/4" thick with two sheets of galvanized and bonderized steel, bonded before attaching die drawn molding to sides and end, mitered reinforcements fused on both corners for added structural strength. Same construction as panel. Pilasters are to be anchored to overhead member (which member is to be supplied by others) with standard 3/8" threaded rod, hex nuts and washers to provide vertical adjustment and necessary strength.

60 Series—Pilasters—Shall be 1-1/4" thick with two sheets of galvanized and bonderized steel, bonded before attaching die drawn molding to sides. Same construction as panel. Pilasters are to be anchored to floor and ceiling with heavy gauge angle.

Hardware—Concealed latch (No. 2000D), coat hook (No. 6200D), hinge brackets (No. 1250D), and door stop keeper (No. 2060D) heavy cast nonferrous alloy, chrome-plated. Concealed hinge (No. 1000D), works on opposing nylon cams under spring tension. Top pivot pin, mounted within door having bearing points above and below hinge bracket.

Fittings—Wall connection brackets for panels and pilasters to be high strength heavy chrome plated. Pilaster trim to be 3" high, .031 stainless steel. All hardware and fittings to be secured with vandal-proof sex bolts or No. 14 screws of proper lengths.

SHOWER CABINET

Double-Wall—Powder Coated Steel Scope—All shower cabinets shall be double-wall powder coated steel with pre-cast terrazzo receptor as manufactured by General Partitions Mfg. Corp., Erie, Pennsylvania.

Walls—Shall be 1" thick with two sheets of level, hot-dipped galvanized and bonderized steel formed and bonded together before attaching die drawn molding on all sides of panels. Filler to be General's Ribcore sound-deadening insulation.

Receptors—Black and white terrazzo. Sizes 32" x 32", 36" x 36", 40" x 40" Neo-corner or 40" x 48" and 40" x 40" Handicapped.

Fittings—Brass drain with stainless steel strainer.

Options—Shower walls may be prepared at factory to receive shower head and valve supplied by others. Curtains, valves, heads, arms and soap dishes are available as optional extras.

STAINLESS STEEL

Scope—All stainless steel toilet partitions shall be (indicate one or more style numbers as required) 30, floor supported; 40, floor supported with headrail; 50, ceiling hung; 60, floor to ceiling; as manufactured by General Partitions Mfg. Corp., Erie, Pennsylvania.

Panel—Double-Wall Construction—Shall be 1" thick with two sheets of Stainless Steel, bonded together before attaching die drawn stainless steel molding on all four sides of panels. Mitered stainless steel reinforcements fused to corners for added structural strength. Filler shall be General's Ribcore sound-deadening insulation.

Doors—To be same construction as panels with Stainless Steel.

30 Series—Pilasters—Shall be 1 1/4" thick with two sheets of Stainless Steel, bonded before attaching die drawn molding to sides and top, mitered reinforcements fused to both corners for added structural strength. Same construction as panel. Pilasters are to be anchored to floor with standard 3/8" threaded rod, hex nuts and washers to provide vertical adjustment and necessary strength.

40 Series—Pilasters—Shall be 1 1/4" thick with two sheets of Stainless Steel, bonded before attaching die drawn stainless steel molding to sides. Same construction as panel. Pilasters are to be anchored to floor with heavy-gauge angle. Top of pilasters to be securely braced with extruded aluminum headrail with integral crown loafer rail.

Headrail—To be integral crown loafer rail, extruded aluminum heat-treated and anodized with necessary fittings.

50 Series—Pilasters—Shall be 1 1/4" thick with two sheets of Stainless Steel, bonded before attaching die drawn molding to sides and end, mitered reinforcements fused on both corners for added structural strength. Same construction as panel. Pilasters are to be anchored to overhead member (which member is to

be supplied by others) with standard 3/8" threaded rod, hex nuts and washers to provide vertical adjustment and necessary strength.

60 Series—Pilasters—shall be 1 1/4" thick with 2 sheets of stainless steel, bonded before attaching die drawn molding to sides. Same construction as panel. Pilasters are to be anchored to floor and ceiling with heavy gauge angle.

Hardware—Concealed latch (No. 2000D), coat hook (No. 6200D), hinge brackets (No. 1250D), and door stop keeper (No. 2060D) heavy cast non-ferrous alloy, chrome-plated. Concealed hinge (No. 1000D), works on opposing nylon cams under spring tension. Top pivot pin, mounted within door having bearing points above and below hinge bracket.

Fittings—Wall connection brackets for panels and pilasters to be high strength heavy chrome plated. Pilaster trim to be 3" high, .031 stainless steel. All hardware and fittings to be secured with vandal-proof sex bolts or No. 14 screws of proper lengths.

SHOWER CABINET

Double-Wall—Stainless Steel series—All shower cabinets shall be double-wall stainless steel with pre-cast terrazzo receptor as manufactured by General Partitions Mfg. Corp., Erie, Pennsylvania.

Walls—Shall be 1" thick with two sheets of stainless steel welded together before attaching die drawn stainless steel molding on all sides of panels. Filler to be General's Ribcore sound-deadening insulation.

Receptors—Black and white terrazzo. Sizes 32" x 32", 36" x 36", 40" x 40" Neo-corner or 40" x 48" and 40" x 40" Handicapped.

Fittings—Brass drain with stainless steel strainer.

Options—Shower walls may be prepared at factory to receive shower head and valve supplied by others. Curtains, valves, heads, arms and soap dishes are available as optional extras.

PLASTIC LAMINATES HIGH PRESSURE

Scope—All plastic laminate high pressure toilet partitions shall be (indicate one or more style numbers as required) 30, floor supported; 40, floor supported with headrail; 50, ceiling hung; 60, floor to ceiling; as manufactured by General Partitions Mfg. Corp., Erie, Pennsylvania.

Doors and Panels—Shall be 1" thick with faces and edging 1/16" general purpose laminated plastic. Bonded under pressure to a solid 45 lb. density particle board core assuring a rigid permanent bond.

30 Series—Pilasters—Shall be 1 1/4" thick with faces and edging 1/16" general purpose laminated plastic. Same construction as panel. Pilasters are to be anchored to the floor with standard 3/8" threaded rod, hex nuts and washers to provide vertical adjustment and necessary strength.

40 Series—Pilasters—Shall be 1 1/4" thick with faces and edging 1/16" general purpose laminated plastic. Same construction as panel. Pilasters are to be anchored to the floor with heavy gauge angle. Top of pilasters to be securely braced with extruded aluminum headrail with integral crown loafer rail.

Headrail—To be integral crown loafer rail, extruded aluminum heat-treated and anodized with necessary fittings.

50 Series—Pilasters—Shall be 1 1/4" thick with faces and edging 1/16" general purpose laminated plastic. Same construction as panel. Pilasters are to be anchored to overhead member (which member is to be supplied by others) with standard 3/8" threaded rod, hex nuts, and washers to provide vertical adjustment and necessary strength.

60 Series—Pilasters—shall be 1 1/4" thick with faces and edging 1/16" general purpose laminated plastic. Same construction as doors and panels. Pilasters are to be anchored to floor and ceiling with heavy gauge angle.

Hardware—Concealed latch (No. 2000CPL), coat hook (No. 6200D), hinge brackets (No. 1250PL), and door stop keeper (No. 2060C-PL) heavy cast non-ferrous alloy, chrome-plated. Concealed hinge (No. 1000PL), works on opposing nylon cams. Top pivot pin, mounted within door having bearing points above and below hinge bracket.

Fittings—Wall connection brackets for panels and pilasters to be high strength heavy chrome plated. Pilaster trim to be 3" high, .031 stainless steel. All hardware and fittings to be secured with vandal-proof sex bolts or No. 14 screws of proper lengths.

S.P.C. (SOLID PHENOLIC CORE)

Scope—All S.P.C. (Solid Phenolic Core) toilet partitions shall be 30 series, floor supported; 40, floor supported with headrail; 50, ceiling hung; 60, floor to ceiling; as manufactured by General Partitions Mfg. Corp., Erie, Pennsylvania.

Doors—Shall be manufactured of solid phenolic core material 3/4" thick with high pressure matte finish melamine surfaces. Edges shall be black.

Panels—Shall be same construction as doors—1/2" thick.

30 Series—Pilasters—shall be 3/4" (1" available) thick solid phenolic core material. Same construction as doors and panels. Pilasters are to be anchored to floor with standard 3/8" threaded rod, hex nuts and washers to provide vertical adjustment and necessary strength.

40 Series—Pilasters—Shall be 3/4" (1" available) thick solid phenolic core material. Same construction as doors and panels. Pilasters are to be anchored to the floor with heavy gauge angle. Top of pilasters to be securely braced with extruded aluminum headrail with integral crown loafer rail.

Headrail—To be with integral crown loafer rail, extruded aluminum heat-treated and anodized with necessary fittings.

50 Series—Pilasters—Shall be 3/4" (1" available) thick solid phenolic core material. Same construction as doors and panels. Pilasters to be anchored to overhead member (which member is to be supplied by others) with standard 3/8" threaded rod, hex nuts, and washers to provide vertical adjustment and necessary strength.

60 Series—Pilasters—Shall be 3/4" (1" available) thick solid phenolic core material. Same construction as doors and panels. Pilasters are to be anchored to floor and ceiling with heavy gauge angle.

Hardware—Surface Mounted Aluminum Slide Latch (No. 2000AL), Coat Hook (No. 6200D), Aluminum Wrap Around Hinge Assembly (No. 1500AL) and Aluminum Door Stop & Keeper (No. 2060AL).

Fittings—Wall connection brackets for panels and pilasters to be high strength heavy chrome plated. Pilaster trim to be 3" high, .031 stainless steel. All hardware and fittings to be secured with vandal-proof sex bolts or No. 14 screws of proper lengths.

SHOWER CABINET

All shower cabinets shall be solid phenolic walls with pre-cast terrazzo receptor as manufactured by General Partitions Mfg. Corp., Erie, Pennsylvania.

Walls—Shall be 1/2" thick solid phenolic (3/4" or 1" thickness also available).

Receptors—Black and white terrazzo. Sizes 32" x 32", 36" x 36", 40" x 40" Neo-corner or 40" x 48" and 40" x 40" handicapped.

Fittings—Brass drain with stainless steel strainer.

Options—Shower walls may be prepared at factory to receive shower head and valve supplied by others. Curtains, valves, heads, arms and soap dishes are available as optional extras.

H.D.P. (HIGH DENSITY POLYMER)

Scope—All H.D.P. (High Density Polymer) toilet partitions shall be 40 series, floor supported with headrail; 60, floor to ceiling; as manufactured by General Partitions Mfg. Corp., Erie, Pennsylvania.

Doors and Panels—Shall be 1" nominal thick (55" high) solid high density polyethylene formed under pressure. Solid color throughout. All edges to be machined radius and all sharp edges removed.

40 Series—Pilasters—Shall be same construction as doors and panels. Pilasters are to be anchored to the floor with heavy gauge angle. Top of pilasters to be securely braced with extruded aluminum headrail with integral crown loafer rail.

Headrail—To be integral crown loafer rail, extruded aluminum heat-treated and anodized with necessary fittings.

60 Series—Pilasters—Shall be same construction as doors and panels. Pilasters are to be anchored to floor and ceiling with heavy gauge angle.

Hardware—Surface Mounted Aluminum Slide Latch (No. 2000AL), Coat Hook (No. 6200D), Aluminum Wrap Around Hinge Assembly (No. 1500AL) and Aluminum Door Stop & Keeper (No. 2060AL).

Fittings—Panels anchored to pilasters with a continuous "U" bracket. Panels and pilasters are anchored to the wall with continuous brackets. Pilaster trim to be 3" high. All hardware and fittings to be secured with vandal-proof sex bolts or No. 14 screws of proper length.

SHOWER CABINET

All shower cabinets shall be high density polymer walls with pre-cast terrazzo receptor as manufactured by General Partitions Mfg. Corp., Erie, Pennsylvania.

Walls—Shall be 1" thick high density polymer.

Receptors—Black and white terrazzo sizes 32" x 32", 36" x 36", 40" x 40" Neo-corner or 40" x 48" and 40" x 40" handicapped.

Fittings—Brass drain with stainless steel strainer.

Options—Shower walls may be prepared at factory to receive shower head and valve supplied by others. Curtains, valves, heads, arms and soap dishes are available as optional extras.

F.R.P. FIBERGLASS REINFORCED PLASTIC

Scope—All F.R.P. Fiberglass reinforced plastic shall be (indicate one or more style numbers as required) 40, floor supported with headrail as manufactured by General Partitions Mfg. Corp., Erie, Pennsylvania.

Doors and Panels—shall be textured fiberglass reinforced plastic bonded under pressure to a treated wood core.

40 Series—Pilasters shall be same construction as doors and panels. Pilaster are to be anchored to floor with heavy gauge stainless steel angle. Top of pilaster to be securely braced with extruded aluminum headrail with integral crown loafer rail.

Headrail —to be integral crown loafer rail, extruded aluminum heat-treated and anodized with necessary fittings.

Hardware—Surface Mounted Aluminum Slide Latch (No. 2000AL) Coat Hook (No. 6200D) Aluminum Wrap Around Hinge Assembly (No. 1500AL) and Aluminum Door Stop & Keeper (No. 2060AL).

Fittings—Wall connection brackets for panels and pilaster to be double high, aluminum stirrup brackets. Pilaster trim to be 3" high. All hardware and fittings to be secured with vandal proof sex bolts or No. 14 screws of proper length.

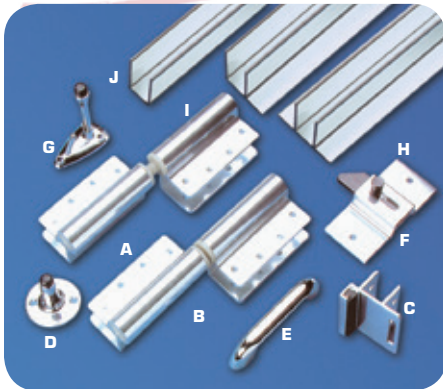

H.D.P. (HIGH DENSITY POLYMER)

- A 1500 AL-T Top Assembly Aluminum Wrap-Around Gravity Hinge
- B 1500 AL-B Bottom Assembly Aluminum Wrap-Around Gravity Hinge
- C 2060-IAL Inswing Stop and Keeper—Aluminum 2060-OAL Outswing (Not Shown) Stop and Keeper—Aluminum
- D 6250 Door Bumper
- E 6300 AL Door Pull
- F 2000 AL Surface Mounted Slide Latch—Aluminum
- G 6200D Combination Coat Hook and Bumper
- H 6000 EXT 1" (54") "T" Bracket
- I 6060 EXT 1" (54") "L" Bracket
- J 6030 EXT 1" (54") "U" Bracket

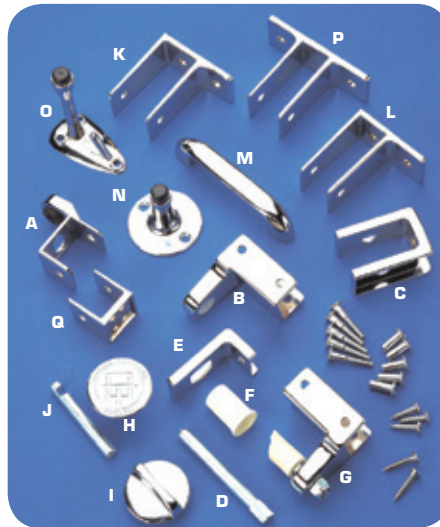

PLASTIC LAMINATE

- A 2060C-PL Combination Stop and Keeper
- B 1250PL-T Top Hinge Bracket
- C 1500PL Concealed Top Hinge
- D 1500PL-T Top Hinge Pin
- E 1000PL Concealed Bottom Hinge
- F 1000PL Female Cam
- G 1250PL-B Bottom Hinge Bracket with Male Cam
- H 2000CPL-B Concealed Latch Exterior Cover
- I 2000CPL-A Concealed Latch Operating Handle
- J 2000CPL Concealed Latch Bar
- K 4120 1 1/4" One Ear Chrome Wall Bracket
- L 4060 1" One Ear Chrome Wall Bracket
- M 6300D Door Pull
- N 6250 Door Bumper
- O 6200D Combination Coat Hook and Bumper
- P 4000 1" Two Ear Chrome Wall Bracket
- Q 4030 1" "U" Chrome Bracket

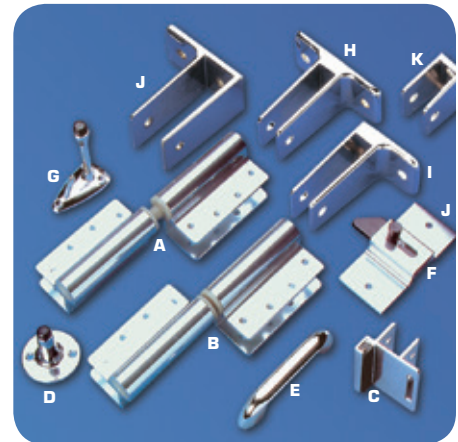

S.P.C. (SOLID PHENOLIC CORE)

- A 1500 AL-T Top Assembly Aluminum Wrap-Around Gravity Hinge
- B 1500 AL-B Bottom Assembly Aluminum Wrap-Around Gravity Hinge
- C 2060-IAL Inswing Stop and Keeper—Aluminum 2060-OAL Outswing (Not Shown) Stop and Keeper—Aluminum
- D 6250 Door Bumper
- E 6300 AL Door Pull
- F 2000 AL Surface Mounted Slide Latch—Aluminum
- G 6200D Combination Coat Hook and Bumper
- H 4000 (.5) 1/2" "T" Chrome Bracket
- I 4060 (.5) 1/2" "L" Chrome Bracket
- J 4060 1" "L" Chrome Bracket
- K 4030 (.5) 1/2" "U" Chrome Bracket



BAKED ENAMEL/STAINLESS STEEL

- A 2060D Combination Stop and Keeper
- B 1250D Top Hinge Bracket
- C 1250D-B Bottom Hinge Bracket
- D 6200D Combination Coat Hook and Bumper
- E 1500D-T Top Hinge Pin
- F 1000D-C Spring Activated Cam Mechanism
- G 1250D-C Bottom Male Cam with Locknut
- H Miscellaneous Screws
- I 4000 1" Two Ear Chrome Wall Bracket
- J 4030 1" "U" Chrome Bracket
- K 2000D-B Concealed Latch Exterior Cover
- L 2000D-A Concealed Latch Operating Handle
- M 6250 Door Bumper
- N 4120 1 1/4" One Ear Chrome Wall Bracket
- O 4060 1" One Ear Chrome Wall Bracket
- P 6300D Door Pull

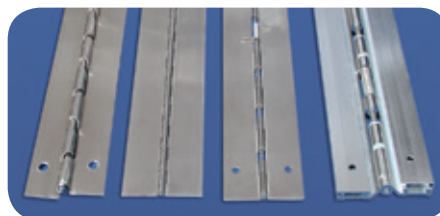

OPTIONAL FULL LENGTH HINGES

- ▶ Stainless Steel Cam
- ▶ Stainless Steel Piano
- ▶ Spring Loaded Stainless Steel
- ▶ Spring Loaded Aluminum Hinge with Covers (Concealed Fasteners)

OPTIONAL HEAVY DUTY FULL LENGTH BRACKETS

Available in Aluminum or Stainless Steel

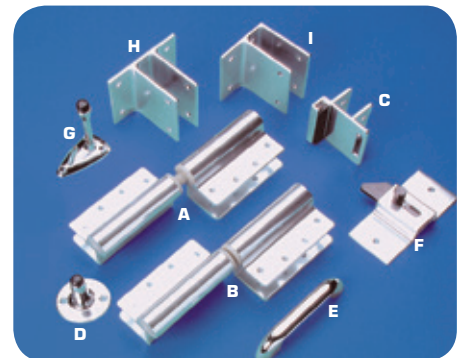

F.R.P. (FIBERGLASS REINFORCED PLASTIC)

- A 1500 AL-T Top Assembly Aluminum Wrap-Around Gravity Hinge
- B 1500 AL-B Bottom Assembly Aluminum Wrap-Around Gravity Hinge
- C 2060-IAL Inswing Stop and Keeper—Aluminum 2060-OAL Outswing (Not Shown) Stop and Keeper - Aluminum
- D 6250 Door Bumper
- E 6300 AL Door Pull
- F 2000 AL Surface Mounted Slide Latch - Aluminum
- G 6200D Combination Coat Hook and Bumper
- H 4000 1" Double Aluminum "T" Bracket
- I 4060 1" Double Aluminum "L" Bracket
- I 4030 1" Double Aluminum "U" Bracket (not shown)



GENERAL PARTITIONS MFG. CORP.
1702 Peninsula Drive • Erie, PA 16505-4243
P.O. Box 8370 • Erie, PA 16505-0370
Phone 814.833.1154 • Fax 814.838.3473
GeneralPartitions.com
mikez@GeneralPartitions.com